

## CODING

-344024

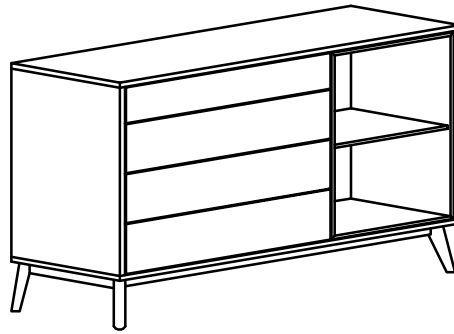







**ISO 9001:2015**  
Reg. No. 000435-1-MY-1-QMS

**LUOMA.COM**

Read the instruction carefully. Remove all the wrapping material, staples and straps from the carton. Refer to the hardware and furniture part list for guidance. Be sure that you have all the parts before you start assembling. Place all the wooden furniture part on a clean and flat soft surface, such as carpet or rubber mat to prevent from scratches.

**Caution**  
**KEEP ALL PARTS OUT OF REACH OF CHILDREN.**

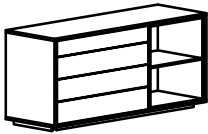
ITEM	HARDWARE LIST	QTY
Ⓐ	JCBC SCREW M6 X 60MM 	8
Ⓑ	SPRING WASHER 5/16" 	8
Ⓒ	FLAT WASHER 5/16" 	8
Ⓓ	ALLEN KEY M5 	1

ITEM	PART LIST	QTY
①	BODY 	1
②	TABLE LEG 	4

## CODING

-344024

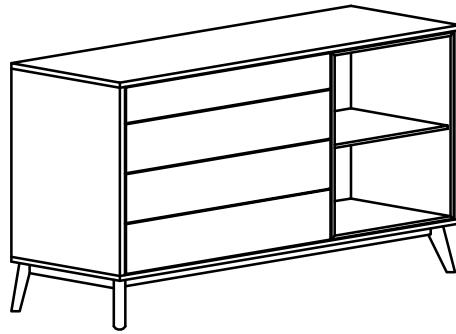

ISO 9001:2015  
Reg. No. 000435-1-MY-1-QMS

LUOMA.com

1

