

**CODING**  
- 244007











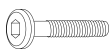

ISO 9001:2015  
Reg. No. 000435-1-MY-1-QMS

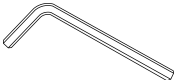
fyndfurniture.com

Read the instructions carefully. Remove all the wrappings, staples and straps from the carton. Refer to the hardware and furniture part list for guidance. Make sure that you have all the parts before you start assembling. Place all the wooden furniture parts on a clean, flat and soft surface, such as a carpet or rubbermat to prevent scratches.

**CAUTION**  
KEEP ALL THE PARTS OUT OF CHILDREN'S REACH.

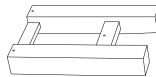
ITEM	PHOTO	HARDWARE NAME	QTY
(A)		JCBC Bolt 4/16" x 2 3/8"	2
(B)		JCBC Bolt 4/16" x 3 9/16"	4
(C)		Barrel Nut 4/16"	6
(D)		Wood Dowel 3/8" x 1 3/16"	6
(E)		Allen Key 3/16" x 2 9/16"	1
(F)		Csk Screw 3/16" x 2 9/16"	12

ITEM	PHOTO	PARTS NAME	QTY
(1)		Bench Seat	1
(2)		Apron	2
(3)		Leg	2
(4)		Bench Stretcher)	1

# LEYTON

CODING  
- 244007



ISO 9001:2015  
Reg. No. 000435-1-MY-1-QMS

fyndfurniture.com

1

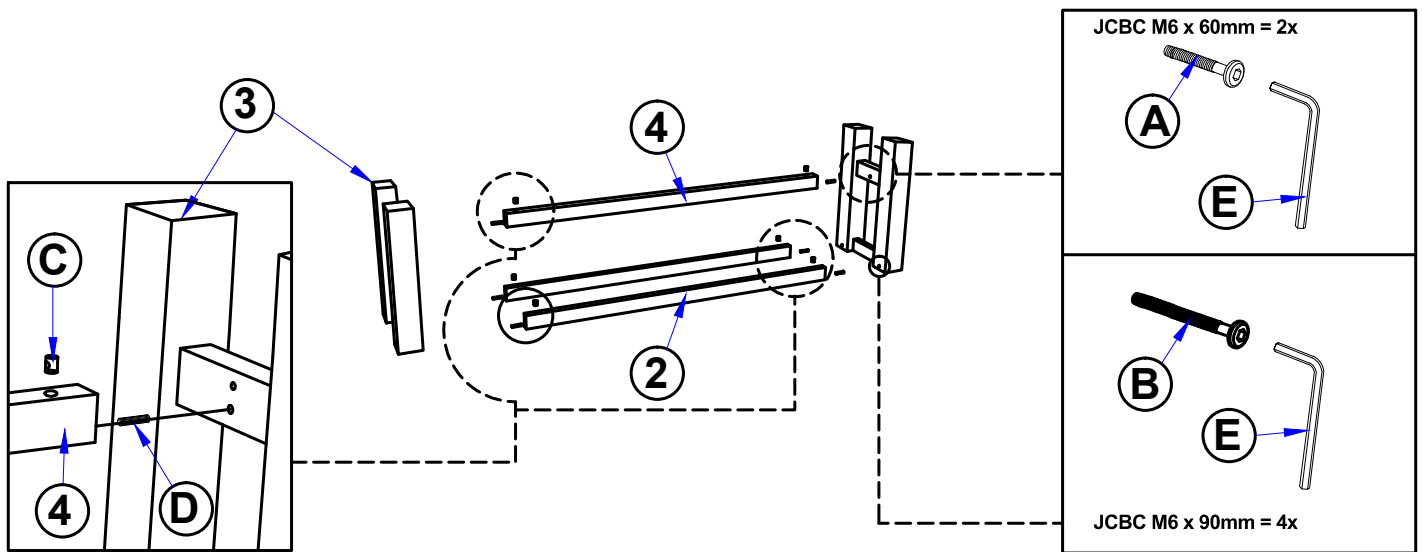

2

