

CODING

- 241570
- 241571

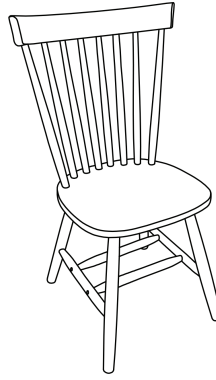

ISO 9001:2015
Reg. No. 000435-1-MY-1-QMS

nesthouz.com

Read the instructions carefully. Remove all the wrappings, staples and straps from the carton. Refer to the hardware and furniture part list for guidance. Make sure that you have all the parts before you start assembling. Place all the wooden furniture parts on a clean, flat and soft surface, such as a carpet or rubbermat to prevent scratches.

CAUTION

KEEP ALL THE PARTS OUT OF CHILDREN'S REACH.

ITEM	PHOTO	HAREWARE NAME	QTY
(A)		Allen Key M4 X 60mm	1
(B)		JCBC Bolt M6 X 30mm	6
(C)		JCBC Bolt M6 X 50mm	4
(D)		Spring Washer M6 X 13mm	10
(E)		Flat Washer M6 X 13mm	10
(F)		Barrel Nut M6 X 9.8mm	4
(G)		Wood Button 14mm	4

ITEM	PHOTO	PARTS NAME	QTY
(1)		Chair Backrest	1
(2)		Chair Leg (L)	1
(3)		Chair Leg (R)	1
(4)		Stretcher	2

CODING
- 241570
- 241571

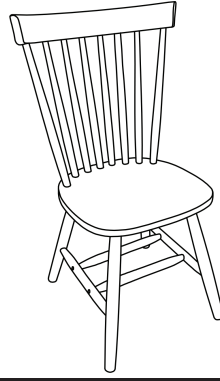

ISO 9001:2015
Reg. No. 000435-1-MY-1-QMS

nesthouz.com

1

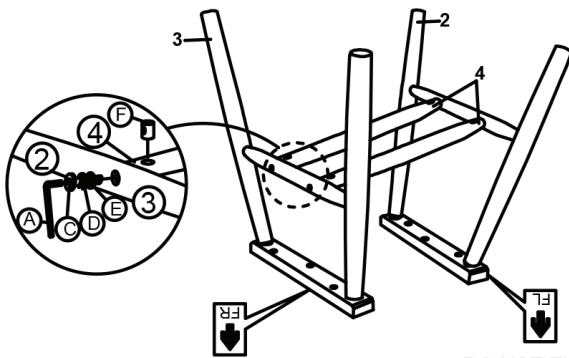

2

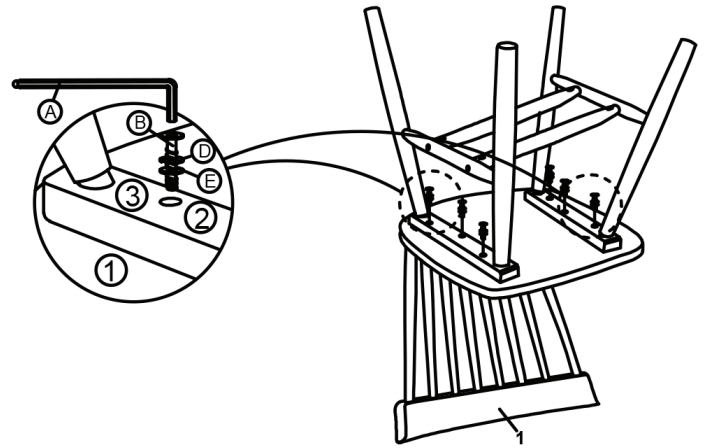

DO NOT TIGHTEN BOLTS UNTIL
CHAIR IS FULLY ASSEMBLED.

3

