

CODING
-152001









ISO 9001:2015
Reg. No. 000435-1-MY-1-QMS



Read the instruction carefully. Remove all the wrapping material. Staples and straps from the carton. Refer to the hardware and furniture part list for guidance. Be sure that you have all the parts before you start assembling. Place all the wooden furniture part on a clean and flat soft surface, such as carpet or rubbermat to prevent from scratches

CAUTION
KEEP ALL THE PARTS OUT REACH OF CHILDREN

ITEM	PHOTO	HARDWARE NAME	QTY
(A)		WASHER Ø6x16	16
(B)		BOLT M6X20	16
(C)		M4 ALLEN KEY	1
(D)		HANDLE	2
(E)		BOLT M6x40	4

ITEM	PHOTO	PARTS NAME	QTY
(1)		MAIN BODY	1
(2)		LEG	4

CODING
-152001



ISO 9001:2015
Reg. No. 000435-1-MY-1-QMS

fynd.
FURNITURE

1

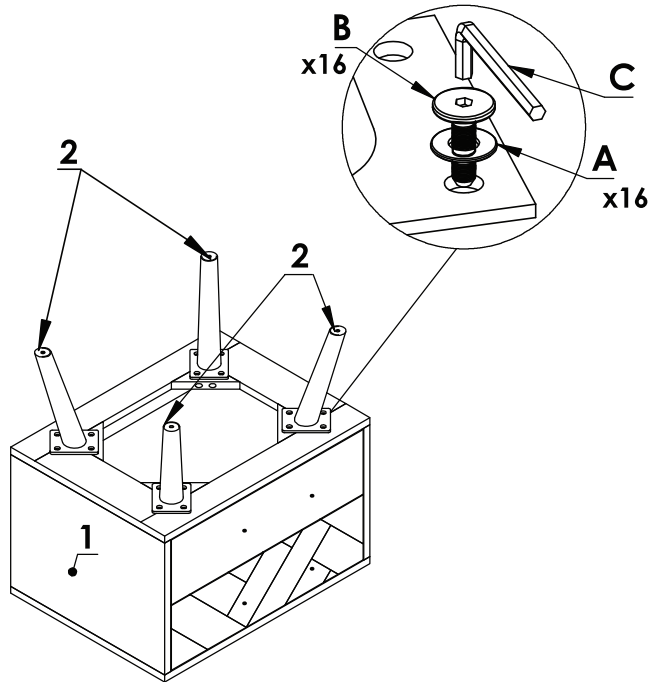

2

