

CODING
-148004



ISO 9001:2015
Reg. No. 000435-1-MY-1-QMS

fyndfurniture.com

Read the instructions carefully. Remove all the wrappings, staples and straps from the carton. Refer to the hardware and furniture part list for guidance. Make sure that you have all the parts before you start assembling. Place all the wooden furniture parts on a clean, flat and soft surface, such as a carpet or rubbermat to prevent scratches.

CAUTION

KEEP ALL THE PARTS OUT OF CHILDREN'S REACH

ITEM	PHOTO	HARDWARE NAME	QTY
(A)		Bolts M8x25	20
(B)		Washers M8 x 22	20
(C)		Lock washer M8 x 13	20
(D)		Allen key K4	1
(E)		Felt	4

ITEM	PHOTO	PARTS NAME	QTY
(1)		Table top	1
(2)		Metal leg	2

CODING
-148004



ISO 9001:2015
Reg. No. 000495-1-MY-1-QMS

fyndfurniture.com

1

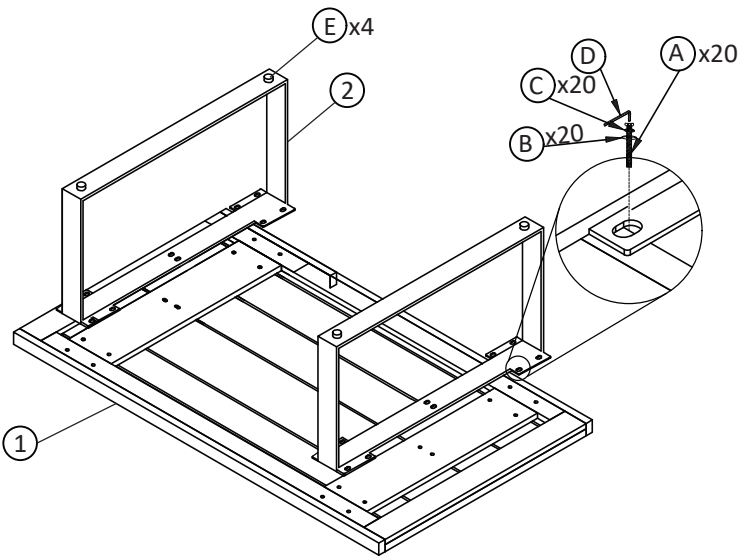

2

