

CODING
- 146098







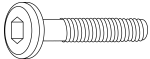

ISO 9001:2015
Reg. No. 000435-1-MY-1-QMS

fyndfurniture.com

Read the instructions carefully. Remove all the wrappings, staples and straps from the carton. Refer to the hardware and furniture part list for guidance. Make sure that you have all the parts before you start assembling. Place all the wooden furniture parts on a clean, flat and soft surface, such as a carpet or rubbermat to prevent scratches.

CAUTION
KEEP ALL THE PARTS OUT OF CHILDREN'S REACH.

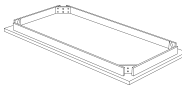
ITEM	PHOTO	HARDWARE NAME	QTY
(A)		JCBC Bolt 5/16" x 2 3/4"	8
(B)		Spring washer 5/16"	8
(C)		Flat Washer 5/16" x 8/9"	8
(D)		Allen Key 3/16" x 2 9/16"	1

ITEM	PHOTO	PARTS NAME	QTY
(1)		Table Top	1
(2)		Table Leg	4

LEYTON

CODING
- 146098



ISO 9001:2015
Reg. No. 000435-1-MY-1-QMS

fyndfurniture.com

1

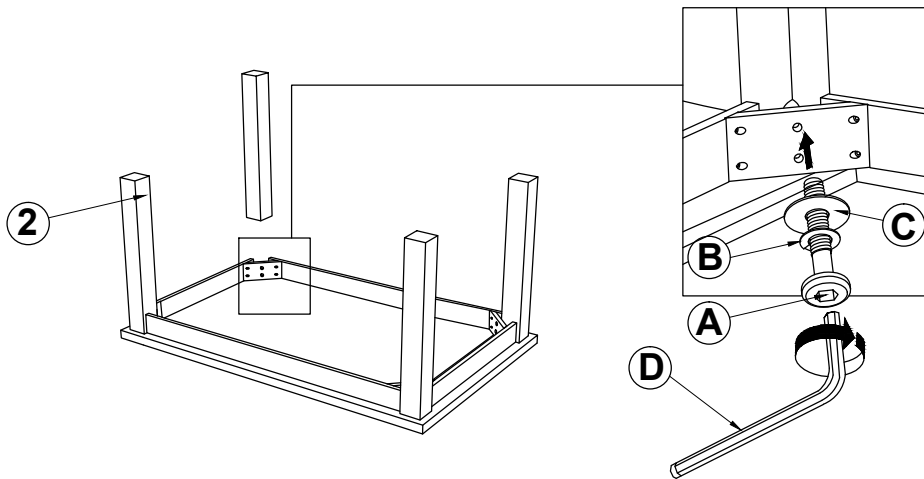
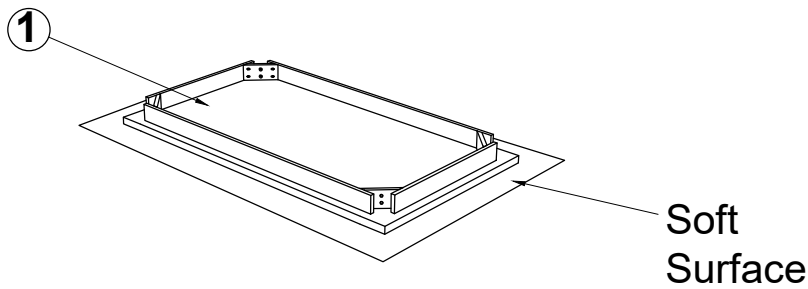

2

