

CODING
- 146091







ISO 9001:2015
Reg. No. 000435-1-MY-1-QMS

fyndfurniture.com

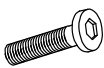
Read the instructions carefully. Remove all the wrappings , staples and straps from the carton. Refer to the hardware and furniture part list for guidance. Make sure that you have all the parts before you start assembling. Place all the wooden furniture parts on a clean, flat and soft surface, such as a carpet or rubbermat to prevent scratches.

CAUTION
KEEP ALL THE PARTS OUT OF CHILDREN'S REACH.

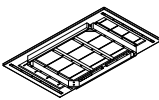
ITEM	PHOTO	HAREWARE NAME	QTY
(A)		Bolts(M8x70)	8
(B)		Flat washers (Ø10/Ø22mm)	8
(C)		Allen key 4mm	1

ITEM	PHOTO	PARTS NAME	QTY
(1)		Table top	1
(2)		Left legs	2
(3)		Right legs	2

CODING
- 146091



ISO 9001:2015
Reg. No. 000435-1-MY-1-QMS

fyndfurniture.com

1

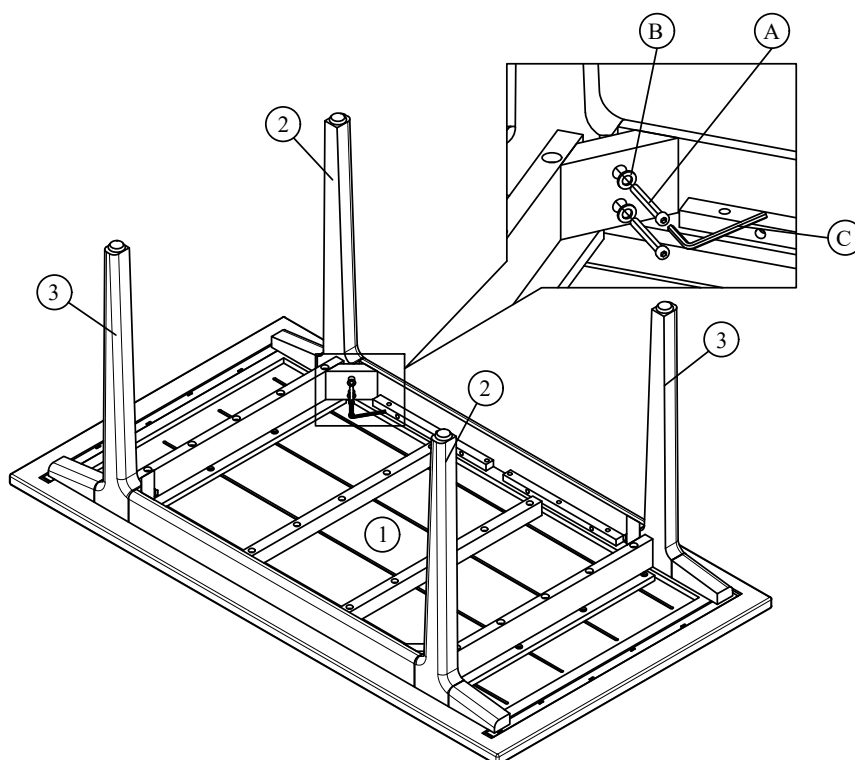

2

