

CODING  
140037

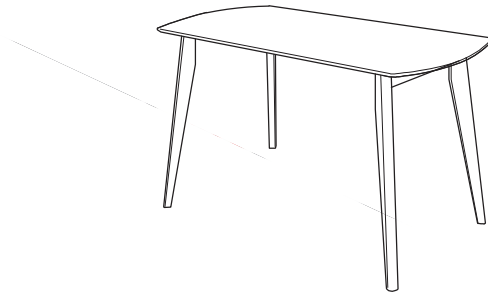







ISO 9001:2015  
Reg. No. 000435-1-ACEY-1-QM0

nesthouz.com

Read the instructions carefully. Remove all the wrappings , staples and straps from the carton. Refer to the hardware and furniture part list for guidance. Make sure that you have all the parts before you start assembling. Place all the wooden furniture parts on a clean, flat and soft surface, such as a carpet or rubbermat to prevent scratches.

**CAUTION**  
KEEP ALL THE PARTS OUT OF CHILDREN'S REACH.

ITEM	PHOTO	HARDWARE NAME	QTY
(A)		JCBC M6 x 70mm	8
(B)		Flat Washer M6	8
(C)		Spring Washer M6	8
(D)		Allen Key M4	1

ITEM	PHOTO	PARTS NAME	QTY
(1)		Table Top	1
(2)		Table Leg	4

CODING  
140037

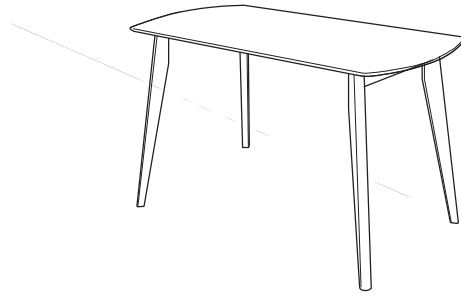

ISO 9001:2015  
Reg. No. 00001-1-MY-1-QMS

nesthouz.com

1

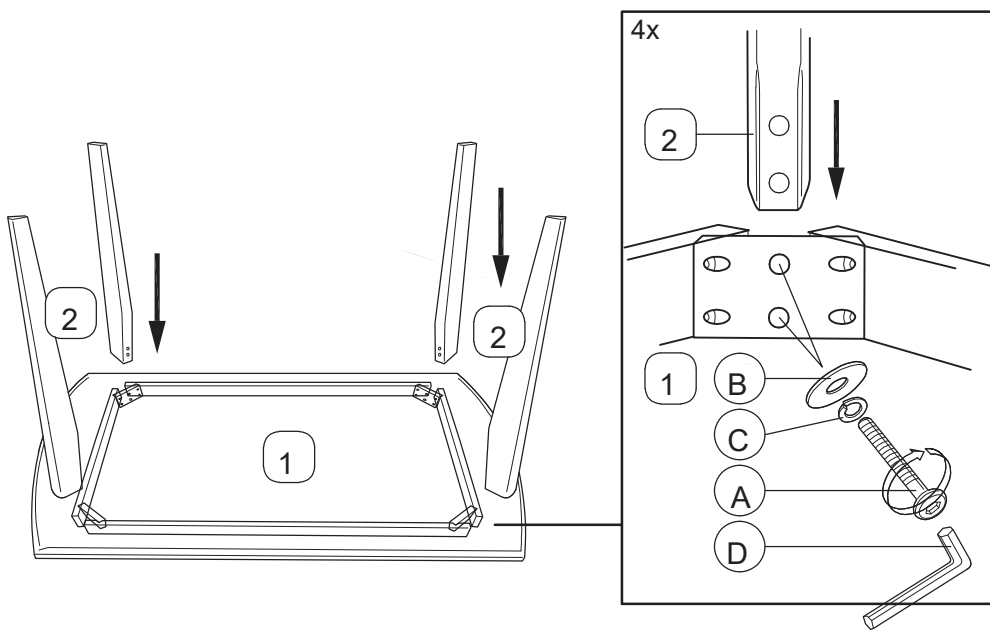

2



CODING  
140037













ISO 9001:2015  
Reg. No. 000435-1-ACEY-1-QM0

nesthouz.com

Read the instructions carefully. Remove all the wrappings, staples and straps from the carton. Refer to the hardware and furniture part list for guidance. Make sure that you have all the parts before you start assembling. Place all the wooden furniture parts on a clean, flat and soft surface, such as a carpet or rubbermat to prevent scratches.

**CAUTION**  
KEEP ALL THE PARTS OUT OF CHILDREN'S REACH.

ITEM	PHOTO	HARDWARE NAME	QTY
(A)		JCBC M6 x 70mm	8
(B)		JCBC M6 x 25mm	8
(C)		Spring Washer M6	8
(D)		CSK M4 x 32mm	12
(E)		Wood Dowel M8 x 30mm	16
(F)		Wood Button 14.5	8
(G)		Allen Key M4	1

ITEM	PHOTO	PARTS NAME	QTY
(1)		Table Top	2
(2)		Table Leg	4
(3)		Table Top	4
(4)		Table Leg	2

CODING  
140037



ISO 9001:2015  
Reg. No. 00005-1-MY-1-QMS

nesthouz.com

1

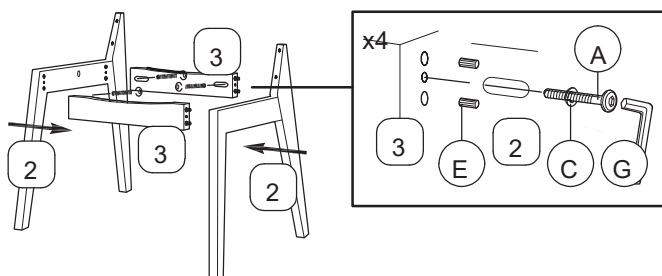

2

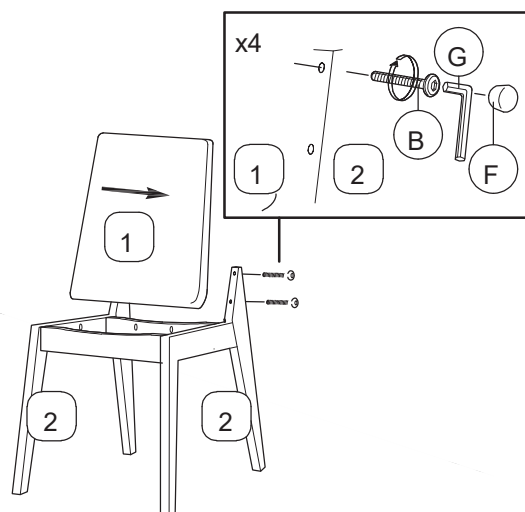

3

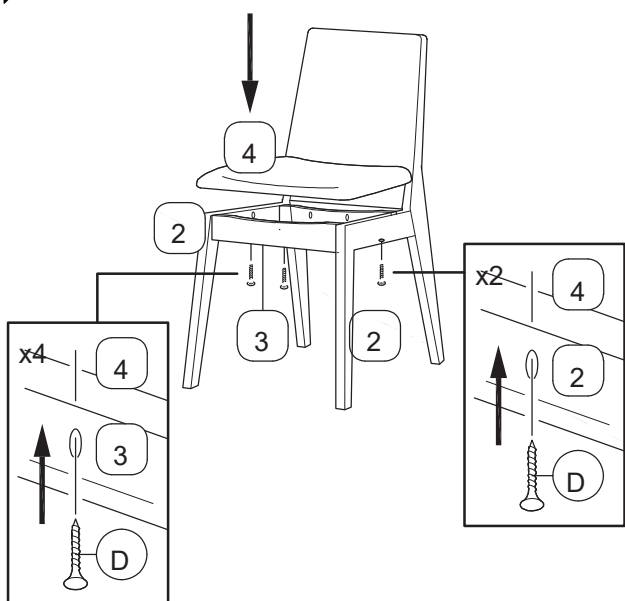

4

