

CODING

- 132126
- 132127

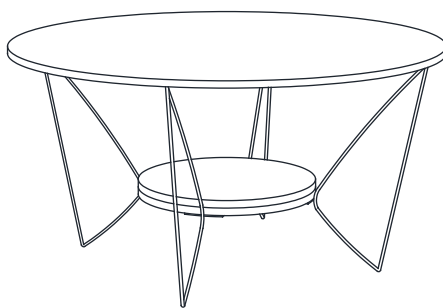





ISO 9001:2015
Reg. No. 000435-1-MY-1-QMS





nuhoom.com

Read the instructions carefully. Remove all the wrappings , staples and straps from the carton. Refer to the hardware and furniture part list for guidance. Make sure that you have all the parts before you start assembling. Place all the wooden furniture parts on a clean, flat and soft surface, such as a carpet or rubbermat to prevent scratches.

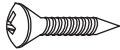
CAUTION

KEEP ALL THE PARTS OUT OF CHILDREN'S REACH.

ITEM	PHOTO	HAREWARE NAME	QTY
(A)		M6 x 15mm	16
(B)		M6 x 12mm	16
(C)		M6 x 19mm	16
(D)		M4 x 100mm (Remark: Only provide 1pc Allen key [M4x100mm] for GIOLA set.)	1
(F)		M4 x 25mm	4

ITEM	PHOTO	PARTS NAME	QTY
(1)		TABLE TOP	1
(2)		LEG	4
(3)		CENTER PANEL	1
(4)		CENTER PANEL SUPPORT	1

CODING
- 132126
- 132127

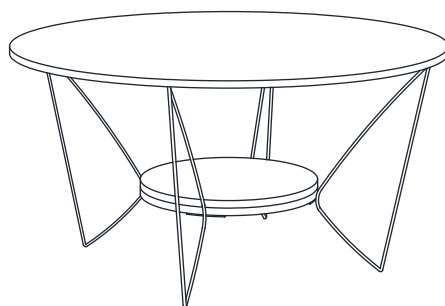

ISO 9001:2015
Reg. No. 000435-1-MY-1-QMS

nuhoom.com

1

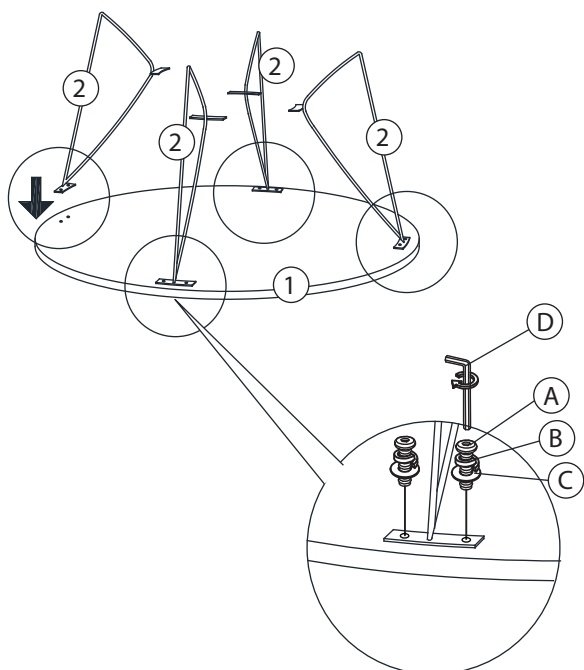

2

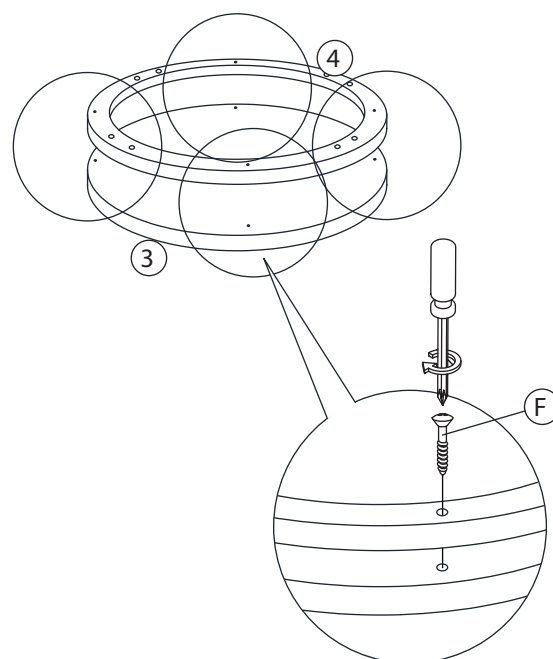

3

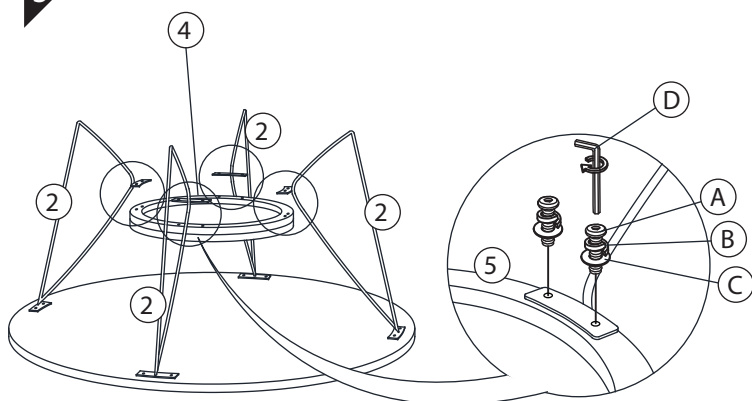

4

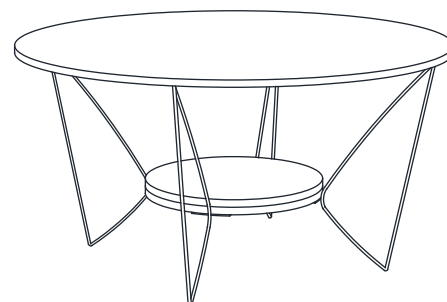

CODING

- 132126
- 132127

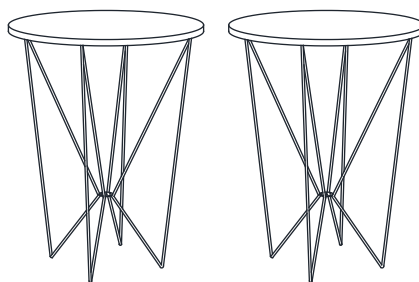





ISO 9001:2015
Reg. No. 000435-1-MY-1-QMS



nuhoom.com

Read the instructions carefully. Remove all the wrappings, staples and straps from the carton. Refer to the hardware and furniture part list for guidance. Make sure that you have all the parts before you start assembling. Place all the wooden furniture parts on a clean, flat and soft surface, such as a carpet or rubbermat to prevent scratches.

CAUTION

KEEP ALL THE PARTS OUT OF CHILDREN'S REACH.

ITEM	PHOTO	HAREWARE NAME	QTY
(A)		M6 x 15mm	24
(B)		M6 x 12mm	24
(C)		M6 x 19mm	16
(D)		M4 x 100mm <small>(Remark: Only provide 1pc Allen key [M4x100mm] for GIOLA set.)</small>	1
(E)		WASHER SUPPORT	2

ITEM	PHOTO	PARTS NAME	QTY
(1)		TABLE TOP	2
(2)		LEG	8

CODING
- 132126
- 132127

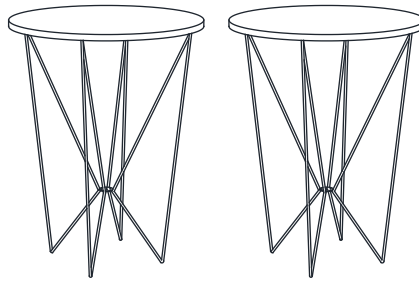

ISO 9001:2015
Reg. No. 000435-1-MY-1-QMS

nuhoom.com

