

CODING
-132095

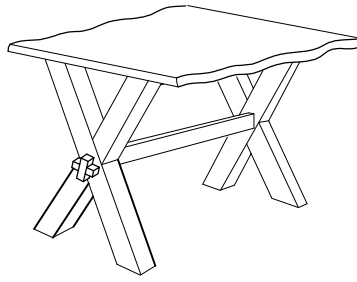







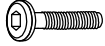

ISO 9001:2015
Reg. No. 000435-1-MY-1-QMS

fynd.
FURNITURE

material, staples and straps from the carton. Refer to the hardware and furniture part list for guidance. Be sure that you have all the parts before you start assembling. Place all the wooden furniture part on a clean and soft surface, such as carpet or rubbermat to prevent from scratches.

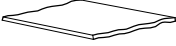
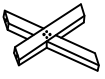
CAUTION
KEEP ALL THE PARTS OUT OF REACH OF CHILDREN.

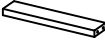
ITEM	HARDWARE LIST	QTY
Ⓐ	JCBC M6 x 35mm 	16
Ⓑ	JCBC M6 x 60mm 	2
Ⓒ	1/4" Spring Washer 	18
Ⓓ	Wood Dowel M8 x 35mm 	4
Ⓔ	Allen Key M4 x 65mm 	1

ITEM	PART LIST	QTY
①	Table Top 	1
②	Table Leg 	2
③	Mounting Plate 	2
④	Cross Bar 	1
⑤	Stopper 	2

CODING
-132095

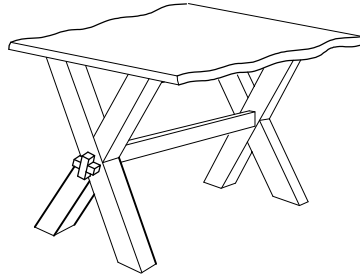

ISO 9001:2015
Reg. No. 000435-1-MY-1-QMS

fynd.
FURNITURE

1

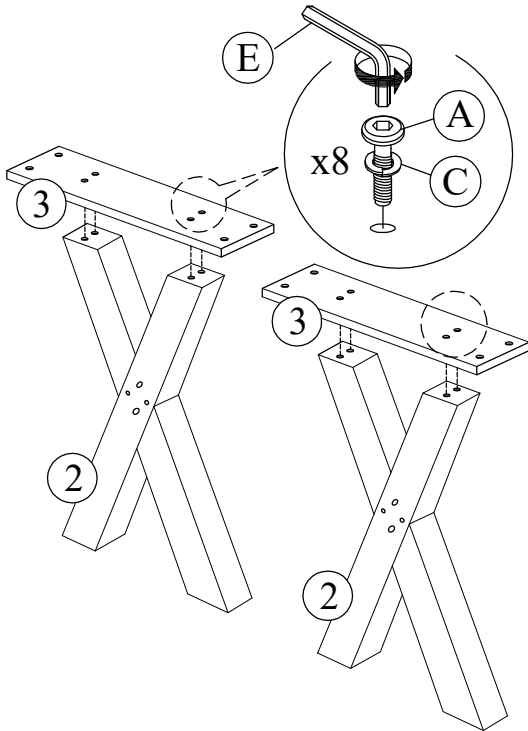

2

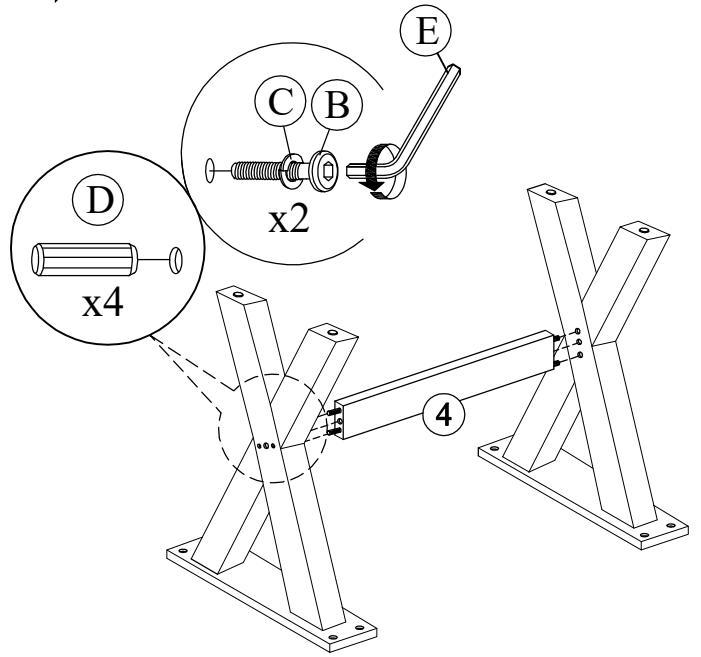

3

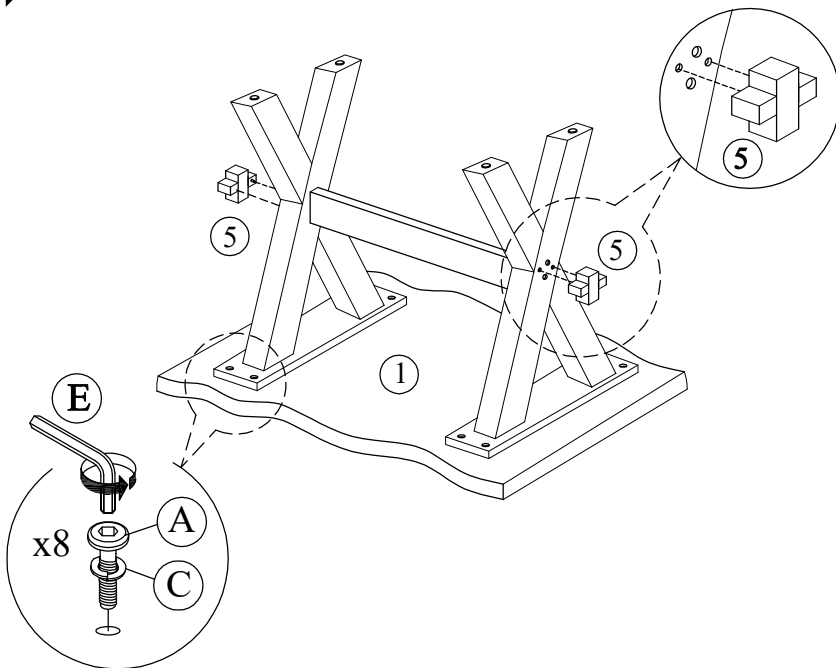

4

