

CODING
- 125006

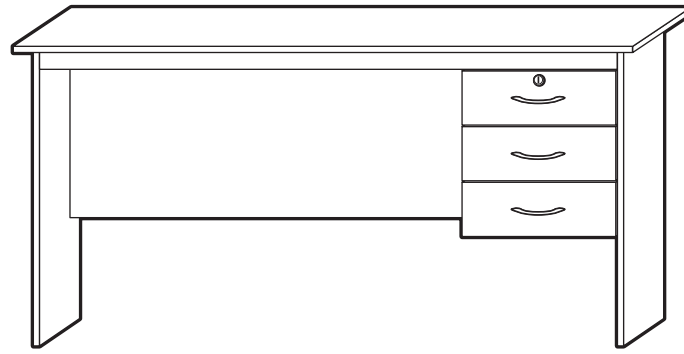

























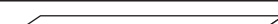

ISO 9001:2015
Reg. No. 000435-1-MY-1-QMS

nuhoom.com

Read the instructions carefully. Remove all the wrappings, staples and straps from the carton. Refer to the hardware and furniture part list for guidance. Make sure that you have all the parts before you start assembling. Place all the wooden furniture parts on a clean, flat and soft surface, such as a carpet or rubbermat to prevent scratches.

CAUTION
KEEP ALL THE PARTS OUT OF CHILDREN'S REACH.

ITEM	HARDWARE LIST		QTY
①		M4 x 45mm Chipboard Screw	14
②		M4 x 32mm Chipboard Screw	30
③		M4 x 25mm Chipboard Screw	8
④		M3.5 x 16mm Chipboard Screw	40
⑤		Nail	30
⑥		Wood Dowel 6 x 25mm	18
⑦		Minifix Pin	4
⑧		Minifix Cam	4
⑨		Square Leg	4
⑩		Drawer Lock	1
⑪		Handle	3
⑫		L Bracket	2
⑬		Drawer Slide	3
⑭		Drawer Slide	3

ITEM	PART LIST		QTY
Ⓐ	Left Side Panel		1
Ⓑ	Right Side Panel		1
Ⓒ	Back Panel		1
Ⓓ	Front Brace Panel		4
Ⓔ	Desktop Panel		1
Ⓕ	Left Side Panel (Drawer)		1
Ⓖ	Right Side Back Panel (Drawer)		1
Ⓗ	Brace Panel (Drawer)		4
Ⓘ	Drawer Front Panel		3
Ⓙ	Drawer Side Panel		6
Ⓚ	Drawer Back Panel		3
Ⓛ	Drawer Bottom Panel		3

CODING
- 125006

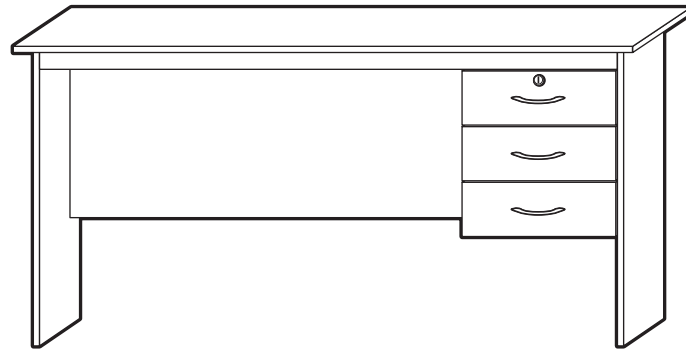

ISO 9001:2015
Reg. No. 000435-1-MY-1-QMS

nuhoom.com

Step 1

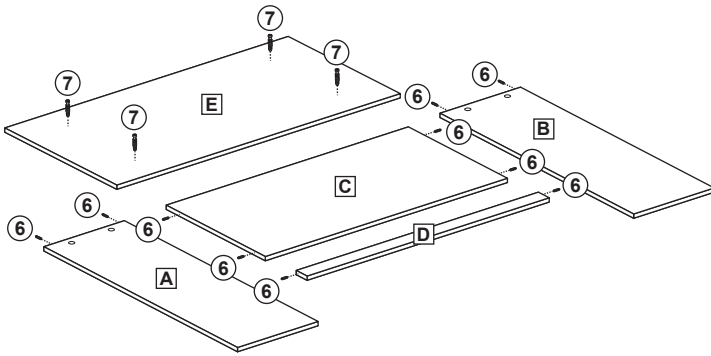

Step 2

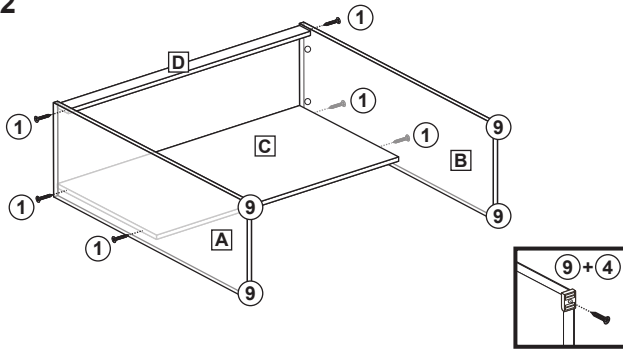

Step 3

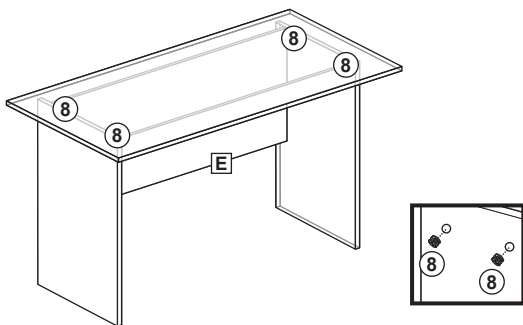

Step 4

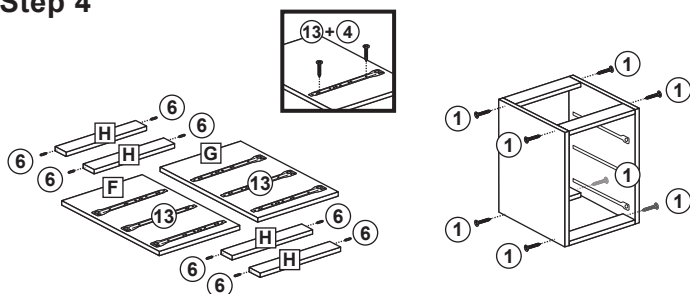

Step 5

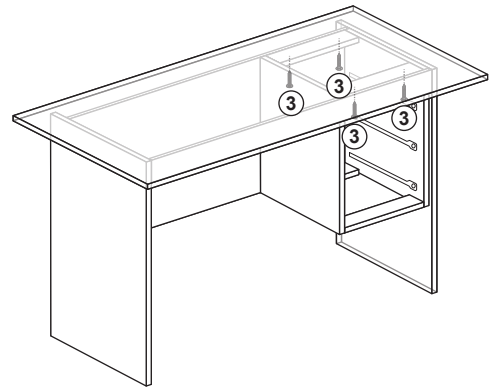

Step 6

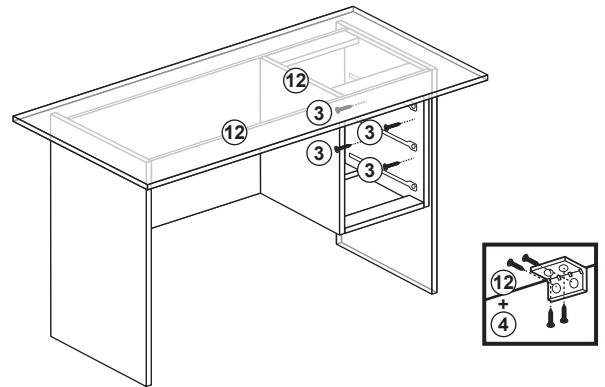

Step 7

