

CODING
- 125001









ISO 9001:2015
Reg. No. 000435-1-MY-1-QMS

nestnordic.com

Read the instruction carefully. Remove all the wrapping material, staples and straps from the carton. Refer to the hardware and furniture part list for guidance. Be sure that you have all the parts before you start assembling. Place all the wooden furniture part on a clean and flat soft surface, such as carpet or rubbermat to prevent from scratches.

CAUTION
KEEP ALL THE PARTS OUT OF REACH OF CHILDREN.

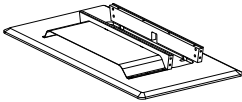
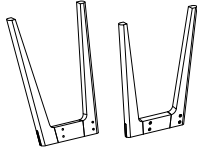
ITEM	HARDWARE LIST	QTY
Ⓐ	M8x70 	8
Ⓑ	M8x15 	8
Ⓒ	Screw 4x15 	10
Ⓓ	Allen key M4 	1

ITEM	PART LIST	SPARE QTY
①		1
②		1L+1R
③		1

CODING
- 125001



ISO 9001:2015
Reg. No. 000435-1-MY-1-QMS

nestnordic.com

1

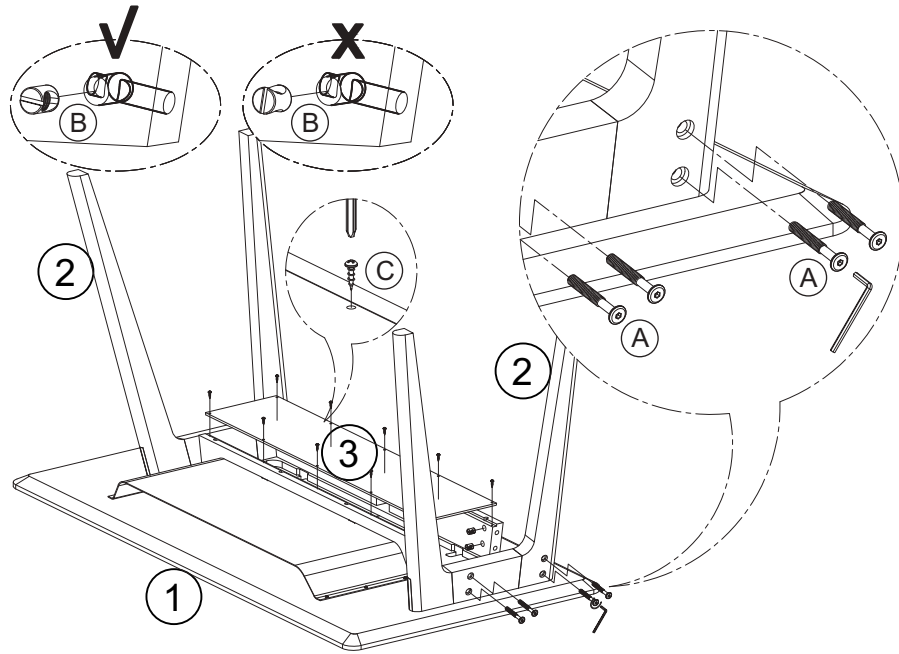

2

