

CODING
-124017







ISO 9001:2015
Reg. No. 000435-1-MY-1-QMS



fyndfurniture.com

Read the instructions carefully. Remove all the wrappings, staples and straps from the carton. Refer to the hardware and furniture part list for guidance. Make sure that you have all the parts before you start assembling. Place all the wooden furniture parts on a clean, flat and soft surface, such as a carpet or rubbermat to prevent scratches.

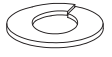
CAUTION

KEEP ALL THE PARTS OUT OF CHILDREN'S REACH

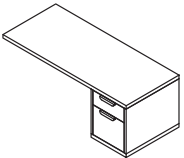
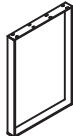
ITEM.	PHOTO	HARDWARE NAME	Q'TY
Ⓐ		BOLTS M6 x 20	16
Ⓑ		WASHERS M6 x 19	16
Ⓒ		LOCK WASHERS M6 x 11	16
Ⓓ		ALLEN KEY 4	1

ITEM.	PHOTO	PARTS NAME	SPARE Q'TY
①		MAIN BODY	1
②		LEFT LEG	1
③		RIGHT LEG	1

CODING
-124017



ISO 9001:2015
Reg. No. 000435-1-MY-1-QMS

fyndfurniture.com

1

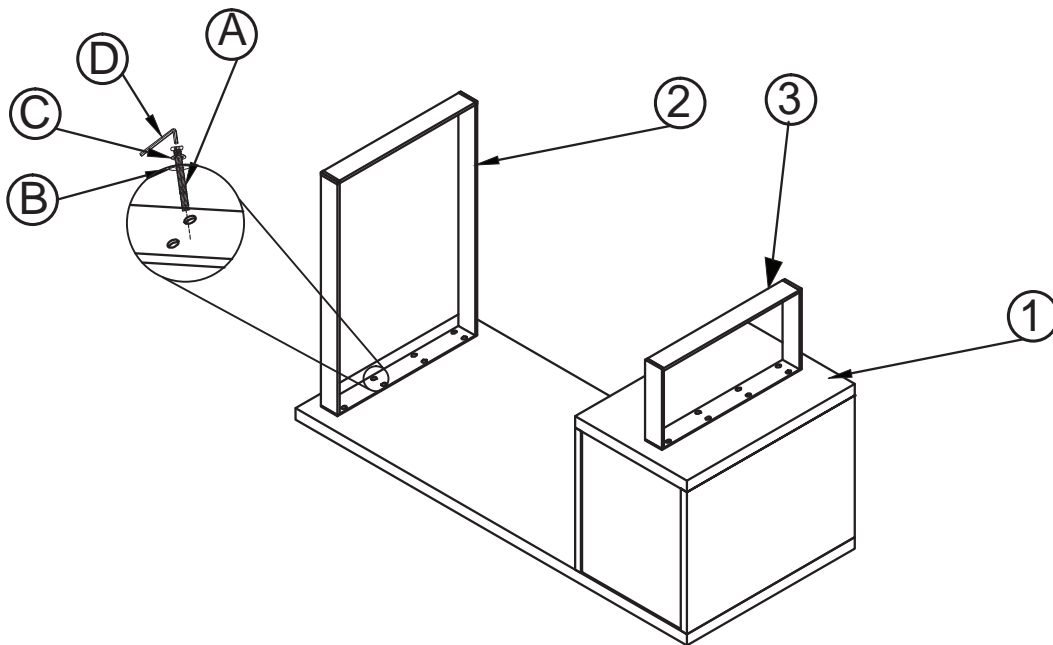

2

