

CODING

-123033

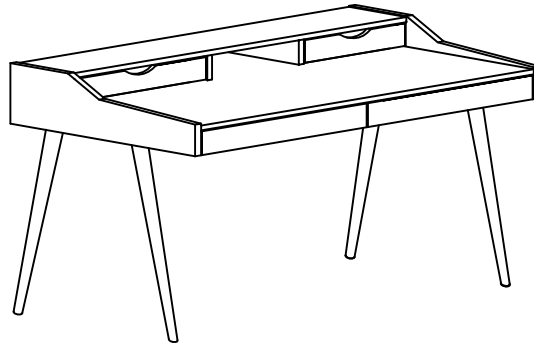





ISO 9001:2015
Reg. No. 000435-1-MY-1-QMS

LUOMA.COM

Read the instruction carefully. Remove all the wrapping material, staples and straps from the carton. Refer to the hardware and furniture part list for guidance. Be sure that you have all the parts before you start assembling. Place all the wooden furniture part on a clean and flat soft surface, such as carpet or rubbermat to prevent from scratches.

Caution
KEEP ALL PARTS OUT OF REACH OF CHILDREN.

ITEM	HARDWARE LIST	QTY
Ⓐ	JCBC SCREW M6 X 60MM 	8
Ⓑ	SPRING WASHER 5/16" 	8
Ⓒ	FLAT WASHER 5/16" 	8
Ⓓ	ALLEN KEY M5 	1

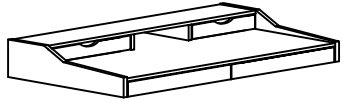
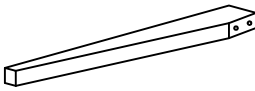
ITEM	PART LIST	QTY
①	BODY 	1
②	TABLE LEG 	4

CODING

-123033

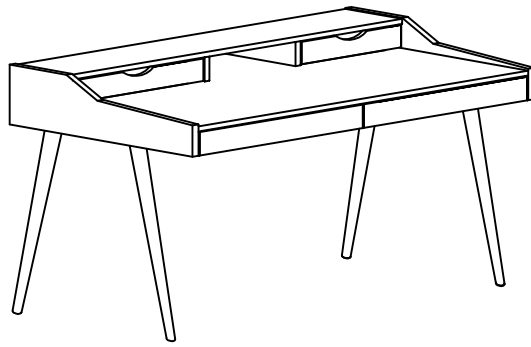

ISO 9001:2015
Reg. No. 000435-1-MY-1-QMS

LUOMA.COM

1

